



5420-82 Ave NW
Edmonton, AB T6B 0E6

t: (780)-919-6792
hello@tomnuk.com

TABLET 16 INSTALL SHEET

1. Make sure the junction box is installed correctly and flush with the drywall of finished surface. Attach black wire to black and white to white at the junction box with supplied wire nuts as well as the green wire to a common ground. Attach crossbar with supplied 8/32 screws supplied. Insert supplied bulb into the socket.

2. Move wood faceplate carefully over the socket and up to the cross bar.

3. Careful thread the globe onto the socket as to not cross the threads and lightly tighten until the fixture is secure.

To replace bulb use step 3 in reverse order.

*** We recommend that all fixtures be installed by a licensed electrician.**

STEP 1

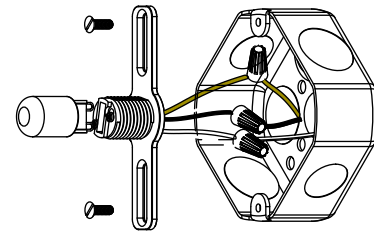

STEP 2

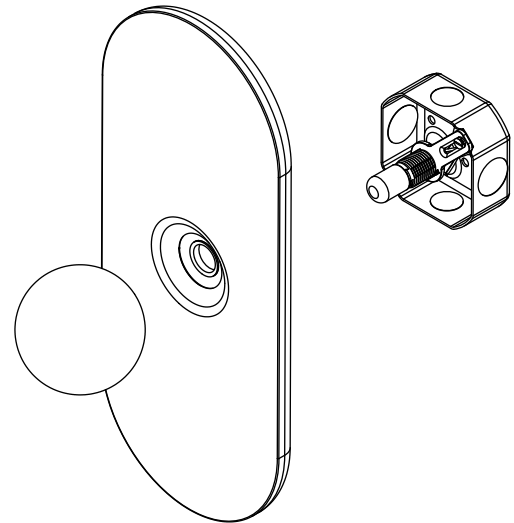

STEP 3

